

SINGER

451K31

ILLUSTRATED
LIST OF PARTS
FOR
No. 451K31 Machine



**A Trade Mark of THE SINGER MANUFACTURING COMPANY

INSTRUCTIONS FOR OILING

BEFORE STARTING THE MACHINE, fill reservoir in base to "high" mark. Inspect often enough to keep oil level from going below "low" mark in base.

To ensure easy running and prevent unnecessary wear of the parts which are in movable contact, the machine requires oiling and when in continuous use, "TYPE A" or "TYPE C" OIL sold only by Singer Sewing Machine Company, should be applied at the beginning of each working day to all oil holes marked "OIL."

"TYPE C" OIL should be used when an oil is desired which will produce a minimum of stain on fabrics, even after a long period of storage.

INDEX

| | Page |
|-------------------------|---------|
| Accessories | 13 |
| Bobbin Winder | 13 & 14 |
| Knee Lifter | 14 |
| Machine No. 451K31 | 5 |
| Miscellaneous Parts | 15 |
| Numerical List of Parts | 17 |
| Thread Unwinder... | 15 |

From the library of: Diamond Needle Corp

| No. | Plate | Name |
|-----------|-------|---|
| 271127 | 18475 | Arm Shaft Connection Belt Pulley with 200363al, 350492c and two 214206 |
| 350492c | 18475 | " " " " Pulley Position Screw |
| 200363al | 18475 | " " " " " Set Screw |
| 214206 | 18475 | " " " " " Spring Flange |
| *276202 | — | Bed |
| 270502 | 2731 | " Slide |
| 276054 | 2730 | Face Plate with 276054 and four 200586h |
| 200586h | 2730 | " " Thread Guard |
| 350503alx | 2730 | " " " " Screw |
| 270553 | 2732 | Feed (back) Bar |
| 270513 | 2732 | " (") " Hinge Pin |
| 350101al | 2732 | " (") " " " Set Screw |
| 52266 | 2732 | " (") " Slide Block |
| 52267 | 2732 | " (") " " " 52266 with 125060 |
| 270526 | 2732 | " (") " " " Crank with 52267 and 200040e |
| 200040e | 2732 | " (") " " " Pinch Screw |
| *125060 | 2732 | " (") " " " Stud |
| 270514 | 2732 | " (") Driving Connection |
| 270515 | 2732 | " (") " " 270514 with 270016 |
| 270015 | 2732 | " (") " " Crank with 200040e |
| 200040e | 2732 | " (") " " Pinch Screw |
| 200545c | 2732 | " (") " " Hinge Screw |
| 201522e | 2732 | " (") " " " Nut |
| 270016 | 2732 | " (") " " Needle Bearing |
| 270017 | 2729 | " (") " Eccentric |
| 270517 | 2729 | " (") " " Adjusting Disc |
| 270508 | 2729 | " (") " " " Spring |
| 270509 | 2729 | " (") " " " " Stop Washer |
| 201403x | 2733 | " (") " " " " Stop Washer Screw |
| 240231 | 2729 | " (") " " Friction Gib |
| 350578xc | 2729 | " (") " " " Adjusting Screw |
| 350562xc | 2729 | " (") " " " " Set Screw |
| 270539 | 2729 | " (") " Flange with 200333c, 200346c, two each 350562xc and 350578c |
| 106506 | — | " (") " " 270539 with 240231, 270017, 270508, 270509, 270517 and two 201403x |
| 200333c | 2729 | Feed (back) Driving Flange Position Screw |
| 200346c | 2729 | " (") " " Set Screw |
| 276203 | 2732 | " (") " Rock Shaft with 350101al and two 270942 |
| 106507 | — | " (") " " 276203 with 270513 and 270553 |
| 270941 | 2732 | " (") " " Centre (2) |
| 201254c | 2732 | " (") " " Set Screw (2) |
| 270942 | — | " (") " " Insert (nylon) |

276226

| No. | Plate | Name |
|-------------|-----------------|---|
| 270521 | 2729 | Feed (back) Regulating Stud |
| 270522 | 2729 | " (") " " Spring |
| 200096c | 2733 | " (") " " " Screw |
| 270551 | 2732 | " (front) Bar |
| 270012 | 2732 | " (") " Centre (2) |
| 200394c | 2732 | " (") " " Set Screw |
| 276058 | 2732 | " (") " Lubricating Felt |
| 52266 | 2732 | " (") " Slide Block |
| 52267 | 2732 | " (") " " " 52266 with 125060 |
| 270506 | 2732 | " (") " " Crank with 52267 and 200040e |
| 200040e | 2732 | " (") " " " Pinch Screw |
| *125060 | 2732 | " (") " " " Stud |
| 270803 | 2732 | " (") Driving Connection |
| 270804 | 2732 | " (") " " 270803 with 270016 |
| 270555 | 2732 | " (") " " Crank with 200040e |
| 270556 | 2732 | " (") " " 270555 with 270653 |
| 350507c | 2732 | " (") " " Hinge Screw |
| 201528e | 2732 | " (") " " " Nut |
| 270653 | 2732 | " (") " " Needle Bearing |
| 200040e | 2732 | " (") " " Pinch Screw |
| 270807 | 2732 | " (") " " Link |
| 270808 | 2732 | " (") " " Hinge Pin |
| 5044700394c | 2732 | " (") " " " Set Screw |
| 270016 | 2732 | " (") " " Needle Bearing |
| 270557 | 2729 | " (") " Eccentric with 200382c and 201220c |
| 201220c | 2729 | " (") " " Position Screw |
| 200382c | 2729 | " (") " " Set Screw |
| 276204 | 2732 | " (") " Rock Shaft with two each 200394c and 270942 |
| 270944 | 2732 | " (") " " " Centre (2) |
| 201254c | 2732 | " (") " " " Set Screw (2) |
| 270942 | — | " (") " " " Insert (nylon) |
| 270559 | 2732 | " (") Indicator |
| 270560 | 2732 | " (") Regulating Index Plate |
| 691f | 2732 | " (") " " " Screw (4) |
| 270561 | 2732 | " (") " Lever with 270559 |
| 270562 | 2732 | " (") " " Connection with 200040e |
| 200040e | 2732 | " (") " " Pinch Screw |
| 200273f | 2732 | " (") " " Hinge Screw |
| 350539x | 2732 | " (") " " Stop Screw Stud (2) |
| 201561x | 2732 | " (") " " " Thumb Nut (2) |
| 228032 | 2732 | " (") " " " Washer (2) |
| 270563 | 2732 | " (") " Shaft |
| 276205 | 2732 | " (") " " Crank with 200040e and 200386c |
| 276206 | 2732 | " (") " " Hinge Stud with 276207 |
| 276207 | — | " (") " " " Oil Packing (wick) |

From the Library of: Darmond Co. Inc.

| No. | Plate | Name |
|----------|-------|--|
| 200138d | 2730 | Rotary Take-up Guard Cover Grill Screw (3) ... |
| 200263xc | 2730 | " " " " Hinge Screw ... |
| 67425 | 2730 | " " " " " " Spring Washer ... |
| 230743c | 2730 | " " " " " " Thrust Washer ... |
| 350586xc | 2730 | " " " " Screw (2) ... |
| 200577al | 2730 | " " " " Screw (3) ... |
| 276043 | 2730 | " " " " Spacer ... |
| 270868 | 2728 | Rotating Hook with 143301, 270878 and two 1253al ... |
| 270869 | 2728 | " " 270868 with 270874xc and four 1053e ... |
| 270870 | 2728 | " " 270869 with 270872, 270876 and three 1367e ... |
| 270871 | 2728 | " " 270870 with 270939 ... |
| 270010 | 2728 | Rotating Hook Bobbin ... |
| 270937 | 2728 | " " " " Case ... |
| 270938 | 2728 | " " " " 270937 with 591f, 1380e and 40394 ... |
| 40393 | 2728 | " " " " Hinge, Nos. 2974, 40392 and 125320 ... |
| 270872 | 2728 | " " " " Holder (chromium plated) ... |
| 270523 | 2728 | " " " " " " Position Bracket ... |
| 200077d | 2728 | " " " " " " " " Screw ... |
| 40392 | 2728 | " " " " " " Latch ... |
| 125320 | 2728 | " " " " " " Lever ... |
| 2974 | 2728 | " " " " " " Fulcrum Pin ... |
| 2975 | 2728 | " " " " " " Spring ... |
| 592e | 2728 | " " " " " " Stop Screw ... |
| 40394 | 2728 | " " " " " " Tension Spring ... |
| 591f | 2728 | " " " " " " " " Regulating Screw ... |
| 1380e | 2728 | " " " " " " " " Screw ... |
| 270939 | 2728 | " " " " " " complete, Nos. 592e, 2975, 40393 and 270938 ... |
| 270873 | 2728 | " " " " " " 270939 with 270872 ... |
| 276212 | 2729 | " " " " Driving Shaft ... |
| 270032 | 2729 | " " " " " " Ball Bearing ... |
| 276213 | 2729 | " " " " " " Bushing with 276046 ... |
| 276046 | 2729 | " " " " " " " " Oil Packing (wick) ... |
| 200346c | 2729 | " " " " " " " " Set Screw ... |
| 270169 | 2729 | " " " " " " Connection Belt Pulley with 214206 and two 200070c ... |
| 200070c | 2729 | " " " " " " " " Connection Belt Pulley Set Screw ... |
| 214206 | 2729 | " " " " " " " " " " Spring ... |
| 276047 | 2729 | " " " " " " " " Flange ... |
| 201220c | 2729 | " " " " " " " " Gear (internal teeth) with 200382c and 201220c ... |
| 200382c | 2729 | " " " " " " " " " " Position Screw ... |
| 270525 | 2729 | " " " " " " " " " " Set Screw ... |
| 270879 | 2733 | " " " " " " " " Oil Lead Wire ... |
| 270038 | 2731 | " " " " " " " " Oil Guard ... |
| 270039 | 2731 | " " " " " " " " Oil Reservoir Cover ... |
| 270039 | 2731 | " " " " " " " " " " Gasket ... |

| No. | Plate | Name |
|----------|-------|--|
| 200041x | 2731 | Rotating Hook Oil Reservoir Cover Screw (6) ... |
| 270878 | 2733 | " " " " Retaining Washer (felt) ... |
| 143301 | 2728 | " " " " " " Wick (felt) ... |
| 270876 | 2728 | " " " " Section ... |
| 1367e | 2728 | " " " " " " Screw ... |
| 1253al | 2728 | " " " " " " Set Screw ... |
| 276059 | 2729 | " " " " " " Shaft ... |
| 270163 | 2729 | " " " " " " Bushing ... |
| 270888 | 2729 | " " " " " " " " Oil Packing (wick) ... |
| 200346c | 2729 | " " " " " " " " Set Screw ... |
| 276060 | 2729 | " " " " " " " " complete, Nos. 270044, 270163, 270164, 270888, 276059, 276062, 350498c and two 201215d ... |
| 270164 | 2729 | Rotating Hook Shaft End Bearing ... |
| 201215d | 2729 | " " " " " " " " Screw ... |
| 202423 | 2729 | " " " " " " " " Oil Filter Wick ... |
| 276061 | 2729 | " " " " " " " " " " Holder ... |
| 276062 | 2729 | " " " " " " " " " " complete, Nos. 202423 and 276061 ... |
| 350498c | 2729 | " " " " " " " " Regulating Screw ... |
| 270044 | 2729 | " " " " " " " " Thrust Washer ... |
| 270874xc | 2728 | " " " " " " " " Thread Guard ... |
| 1053e | 2728 | " " " " " " " " " " Screw ... |
| 2102 | 2730 | Tension Disc ... |
| 276048 | 18478 | " " " " " " " " Releaser (adjustable) ... |
| 200132c | 18478 | " " " " " " " " " " Screw ... |
| 32572 | 2730 | " " " " " " " " Releasing Disc ... |
| 270086 | 2730 | " " " " " " " " " " Pin ... |
| 13710 | 2730 | " " " " " " " " " " Spring ... |
| 50304c | 2730 | " " " " " " " " " " Stud ... |
| 52098 | 2730 | " " " " " " " " " " 50304c with 1560c ... |
| 50305c | 2730 | " " " " " " " " " " Set Screw ... |
| 276055 | 2730 | " " " " " " " " " " Thread Guide Pin ... |
| 1560c | 2730 | " " " " " " " " " " Thumb Nut ... |
| 276049 | 2730 | " " " " " " " " " " complete, Nos. 13710, 32572, 39652, 52083, 52098, 270086 and two 2102 ... |
| 276050 | 2730 | Thread Cutter ... |
| 200583h | 2730 | " " " " " " " " " " Screw ... |
| 276051 | 2730 | " " " " " " " " " " Guide ... |
| 263118 | 18478 | " " " " " " " " " " (on Needle Bar Bushing) ... |
| 350503ax | 2730 | " " " " " " " " " " Screw ... |
| 276057 | 18478 | " " " " " " " " " " Pull-off ... |
| 200145c | 18478 | " " " " " " " " " " Screw (2) ... |
| 276052 | 2730 | " " " " " " " " " " Retainer (front) ... |
| 200397h | 2730 | " " " " " " " " " " (") Set Screw ... |
| 270080 | 2730 | " " " " " " " " " " (rear) ... |
| 200366h | 2730 | " " " " " " " " " " (") Set Screw ... |

| No. | Plate | Name |
|--------|-------|--|
| 39652 | 2730 | Thread Take-up Spring |
| 52083 | 2730 | " " " Regulator with 50305c |
| 453xc | 2730 | " " " " Set Screw |
| 270571 | 2733 | Throat Plate (medium needle hole) for 270566 and 270567 |
| 691f | 2733 | " " Screw (2) |

ACCESSORIES

| No. | Plate | Name |
|--------|-------|---|
| 25878 | 2627 | Cloth Guide |
| 50190 | 2627 | " " Thumb Screw |
| 12361 | 2627 | Machine Hinge Connection (2) |
| 41400 | 2627 | " Rest Pin (wood) |
| 88 × 1 | --- | Needles, six, size 16 |
| 120342 | 2627 | Oiler (copper plated) with 120343 |
| 120343 | 2627 | " Spout (3½ in. long) |
| 270010 | 2728 | Rotating Hook Bobbin (2) |
| 270155 | 2729 | " " Oil Reservoir Oil Gauge |
| 120378 | 2627 | Screw Driver (bobbin case) |
| 85318 | 2627 | Screw Driver |
| --- | --- | Tin of Oil (½ pint) |
| 240566 | --- | Wrench |
| 228478 | 18314 | Drip Pan with four ¾ in. wire nails... .. |

PRESSER FOOT

(for General Work)

| No. | Plate | Name |
|-------|-------|--|
| 86659 | --- | Presser Foot Plate |
| 86660 | --- | Presser Foot Shank |
| 86661 | 2733 | Presser Foot (hinged), Complete, Nos. 86659 and 86660 |

BOBBIN WINDER

(SWINGING AUTOMATIC, RIGHT HAND)

FOR "V" BELT DRIVE

| No. | Plate | Name |
|---------|-------|-------------------------------------|
| 259428 | 2624 | Brake (leather) |
| 259429 | 2624 | " Clamp |
| 200113f | 2624 | " " Screw |
| 225453 | 2624 | Frame with 202277 and 259660 |
| 225454 | 2624 | " Hinge Pin |
| 202277 | 2624 | " Oil Packing (wick) |
| 259660 | 2624 | " " Well Washer |
| 225455 | 2624 | " Spring |
| 225456 | 2624 | " " Plunger |
| 104211 | 2624 | Pulley with 200380c |
| 200380c | 2624 | " Set Screw |
| 225381 | 2624 | Spindle |
| 225444 | 2624 | Stop Latch |
| 200056e | 2624 | " " Screw |
| 225458 | 2624 | " " Thumb Lever... .. |
| 225459 | 2624 | " " " " Hinge Stud |
| 225459 | 2624 | " " " " Joint Stud |
| 202478 | 2624 | " " Trip Lever |
| 200299h | 2624 | " " " " Hinge Screw |

| No. | Plate | Name |
|---------|-------|--|
| 225461 | 2624 | Tension Bracket with 201499h |
| 200082d | 2624 | " " Screw |
| 228026 | 2624 | " " " Washer |
| 2102 | 2624 | " Disc |
| 13710 | 2624 | " Spring |
| 201499h | 2624 | " Stud |
| 201572h | 2624 | " " Thumb Nut |
| 225462 | 2624 | Bobbin Winder Tension Bracket, complete, Nos. 13710, 201572h, 225461 and two 2102 |
| 259430 | 2624 | Bobbin Winder and Tension Bracket Base |
| 104212 | 2624 | " " (swinging automatic, right hand), complete, Nos. 104211, 200056e, 200082d, 200113f, 200299h, 202478, 225381, 225444, 225453 to 225456, 225458, 225462, 228026, 259428 to 259430, two each 225459 and wood screws $\frac{3}{4}$ in. No. 12 R.H.B. |

KNEE LIFTER

| No. | Plate | Name |
|---------|-------|---|
| 228713 | 18311 | Rock Lever with two 350231c |
| 228707 | 18311 | " " Bracket with 200347c and three wood screws $\frac{3}{4}$ in., No. 12 |
| 228709 | 18311 | " " Bracket 228707, with 228363, 228367, 228386, 228455 and 228713 |
| 228370 | 18311 | " " Extension with 200530c |
| 350231c | 18311 | " " " Set Screw |
| 228363 | 18311 | " " Hinge Pin |
| 228364 | 18311 | " " Knee Plate with 350231c |
| 228388 | 18311 | " " " " Arm |
| 350231c | 18311 | " " " " " Set Screw |
| 350231c | 18311 | " " " " " Set Screw |
| 228455 | 18311 | " " Position Spring |
| 228365 | 18311 | " " Rod |
| 200530c | 18311 | " " " Set Screw |
| 228386 | 18311 | " " Spring |
| 228367 | 18311 | " " Stop Stud |
| 200347c | 18311 | " " " " " Set Screw |
| 228710 | 18311 | Knee Lifter Rock Lever, complete, Nos. 228364, 228365, 228370, 228388 and 228709 |

(Other Knee Lifter parts are listed with parts of Machine Head).

THREAD UNWINDER

| No. | Plate | Name |
|---------|-------|--|
| 228692 | 18362 | Spool Pin |
| 201528h | 18362 | " " Nut |
| 228693 | 18362 | " " Washer |
| 225257 | 18362 | " Rest (for two spools) (flat) with 201018c, two each 201528h, 228692 and 228693 |
| 150203 | 18362 | Spool Rest Cushion (felt) |
| 225388 | 18362 | " " Rod |
| 200383c | 18362 | " " " Set Screw |
| 201018c | 18362 | " " Set Screw |
| 259658 | 18362 | " Stand with 200383c |
| 225391 | 18362 | Thread Guide |
| 201696h | 18362 | " " Lock Nut |
| 225326 | 18362 | " " Position Cup |
| 225324 | 18362 | " " Rod with 208al and 225322 |
| 208al | 18362 | " " " Screw |
| 225322 | 18362 | " " " Washer |
| 225258 | 18362 | " Unwinder (for two spools), complete, Nos. 201696h, 225257, 225324, 225326, 225388, 259658, two each 150203 225391 and three wood screws $\frac{3}{4}$ in., No. 12 |

MISCELLANEOUS PARTS

USED IN CONJUNCTION WITH THREAD UNWINDER

| No. | Plate | Name |
|--------|-------|--|
| 259370 | 18362 | Spool Pin |
| 259378 | 18362 | " " Arm with 217e and 259379 |
| 232896 | 18362 | " " " Bracket with two 448al |
| 448al | 18362 | " " " " Set Screw |
| 448al | 18362 | " " " Set Screw |
| 259371 | 18362 | " " Cap (bakelite) |
| 1010f | 18362 | " " Hinge Screw |
| 259379 | 18362 | " " Retaining Spring |
| 217e | 18362 | " " " " Screw |
| 259372 | 18362 | " " Washer |
| 259373 | 18362 | " " complete, Nos. 1010f and 259370 to 259372 |
| 60913 | 18362 | " Weight with 60914 |
| 60914 | 18362 | " " Centre Pin |
| 225377 | 18362 | " Wire, for small spools |
| 27739 | 18362 | Thread Cone (wood) |
| 225390 | 18362 | " " Holder |

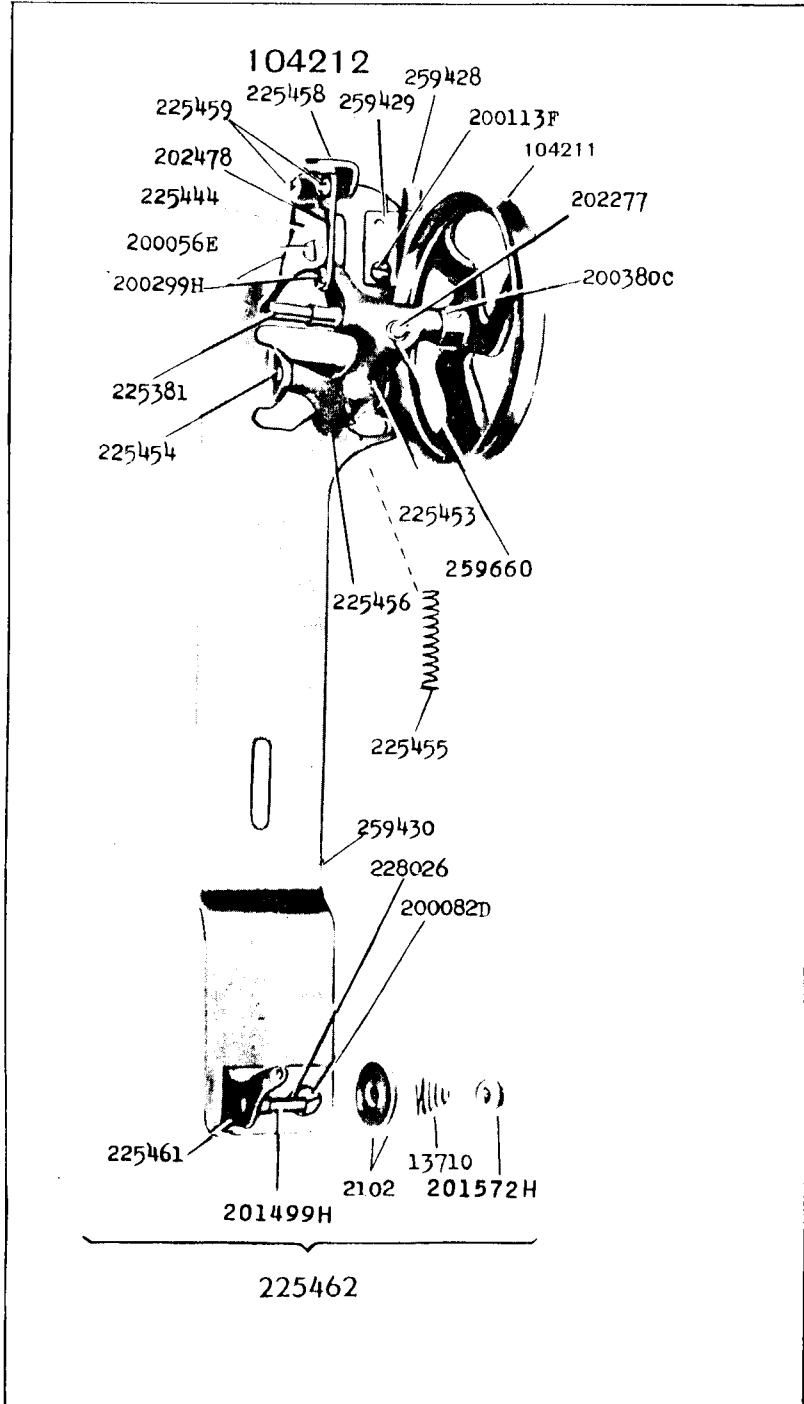

From the library of: Diamond Needle Corp

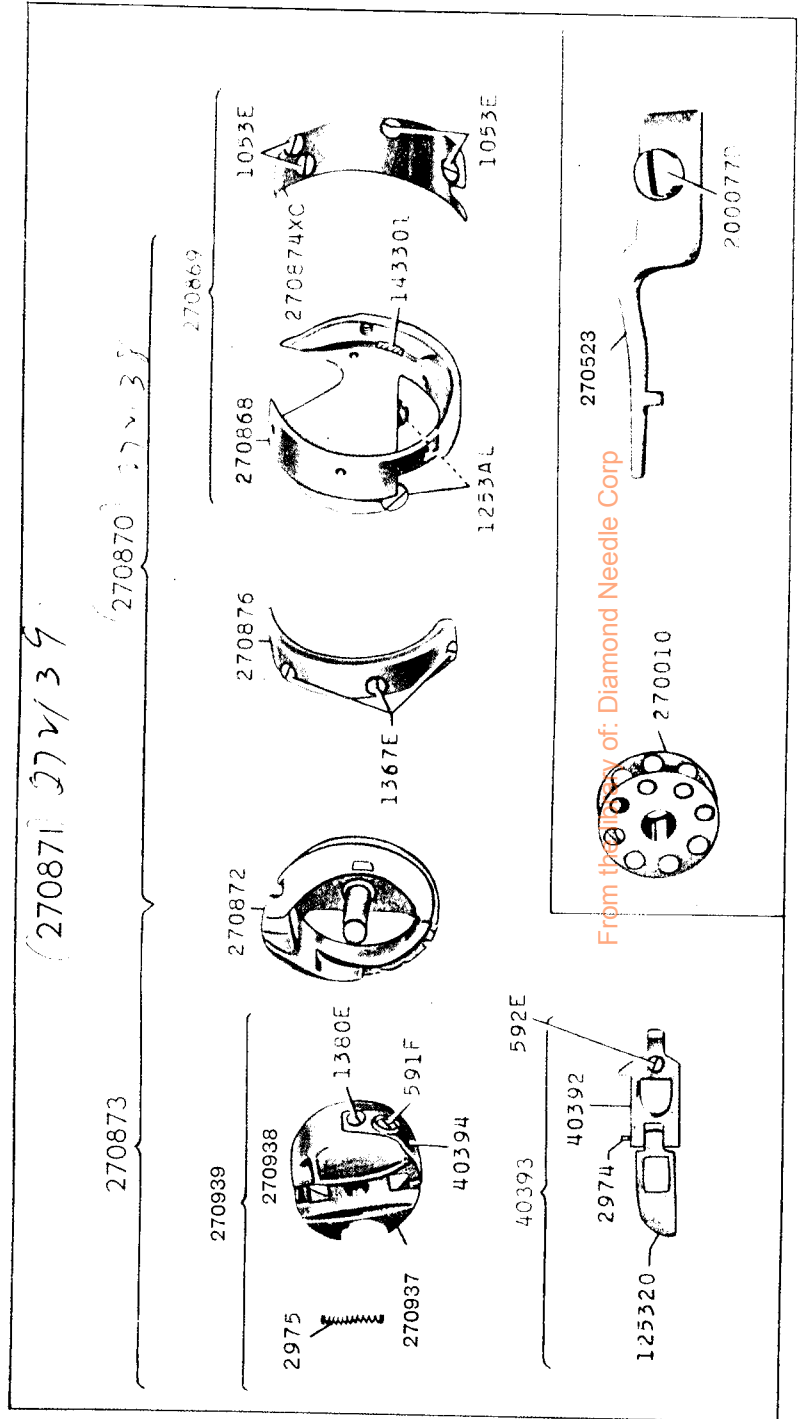
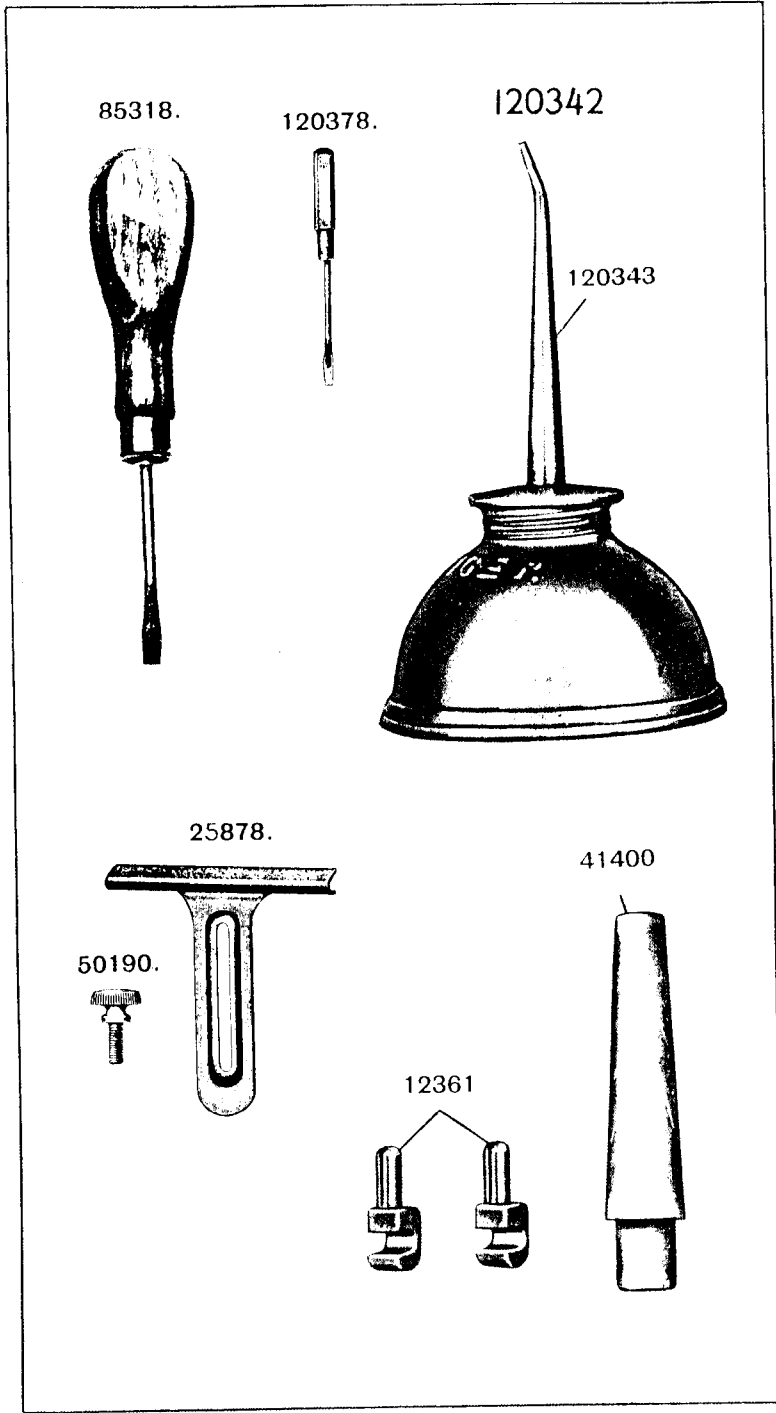

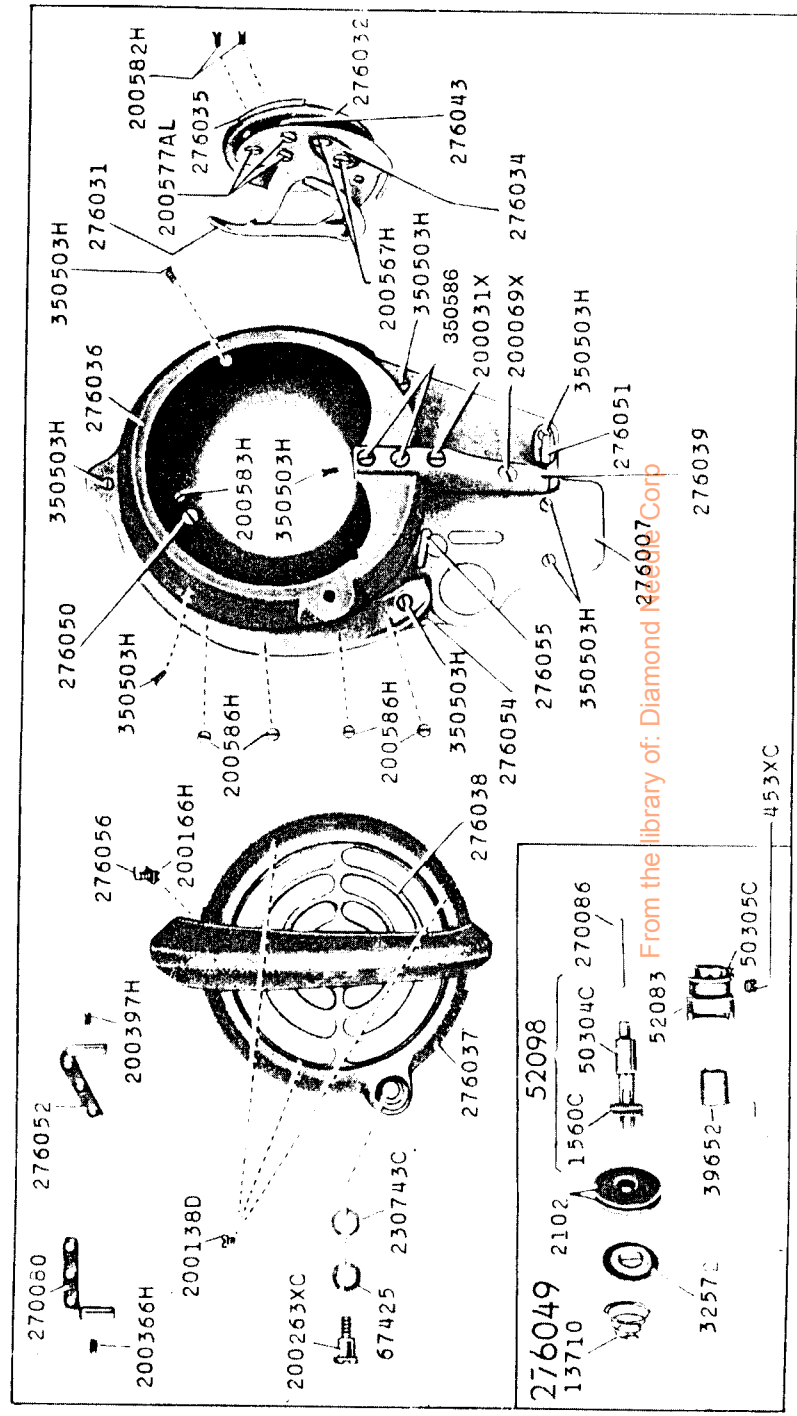
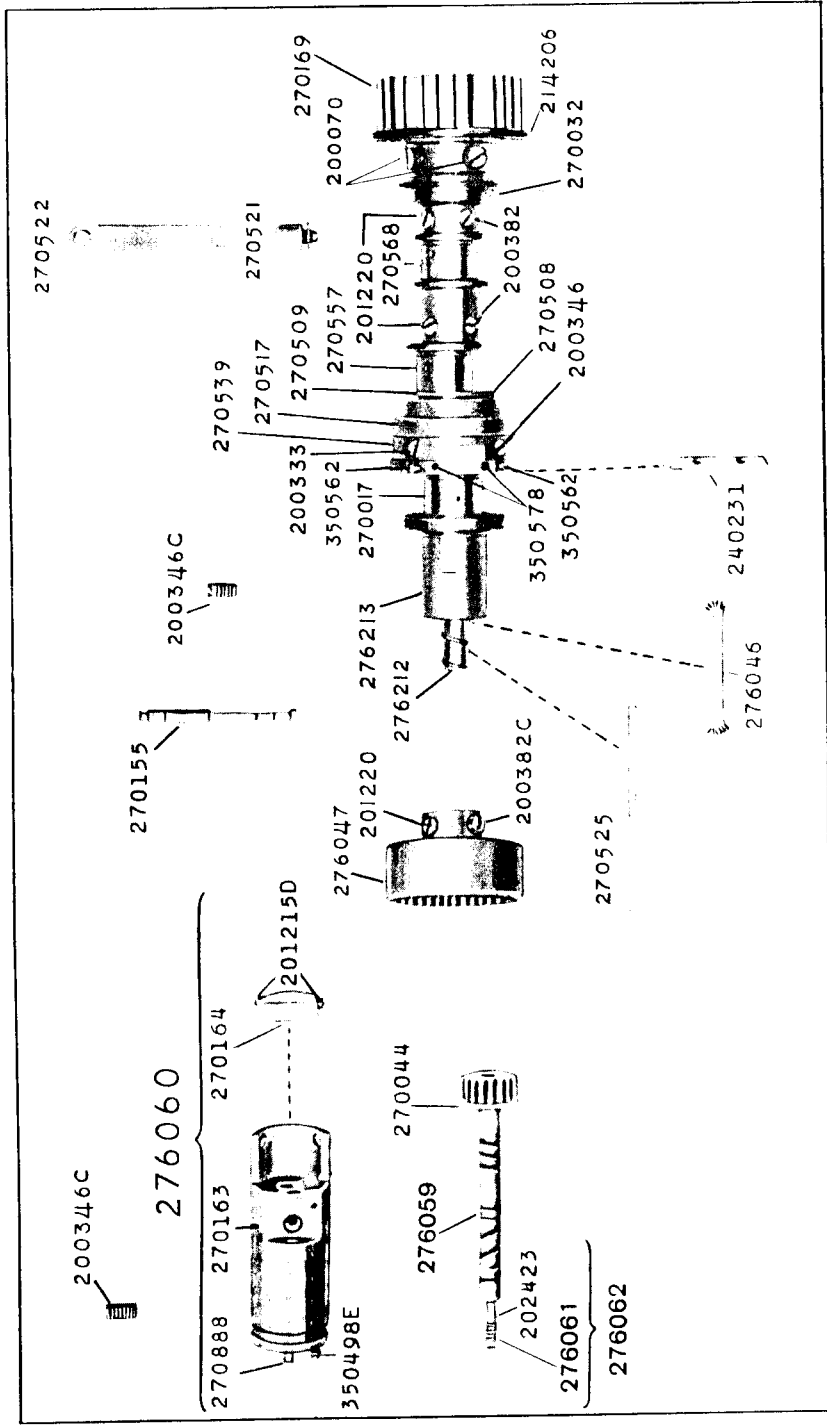

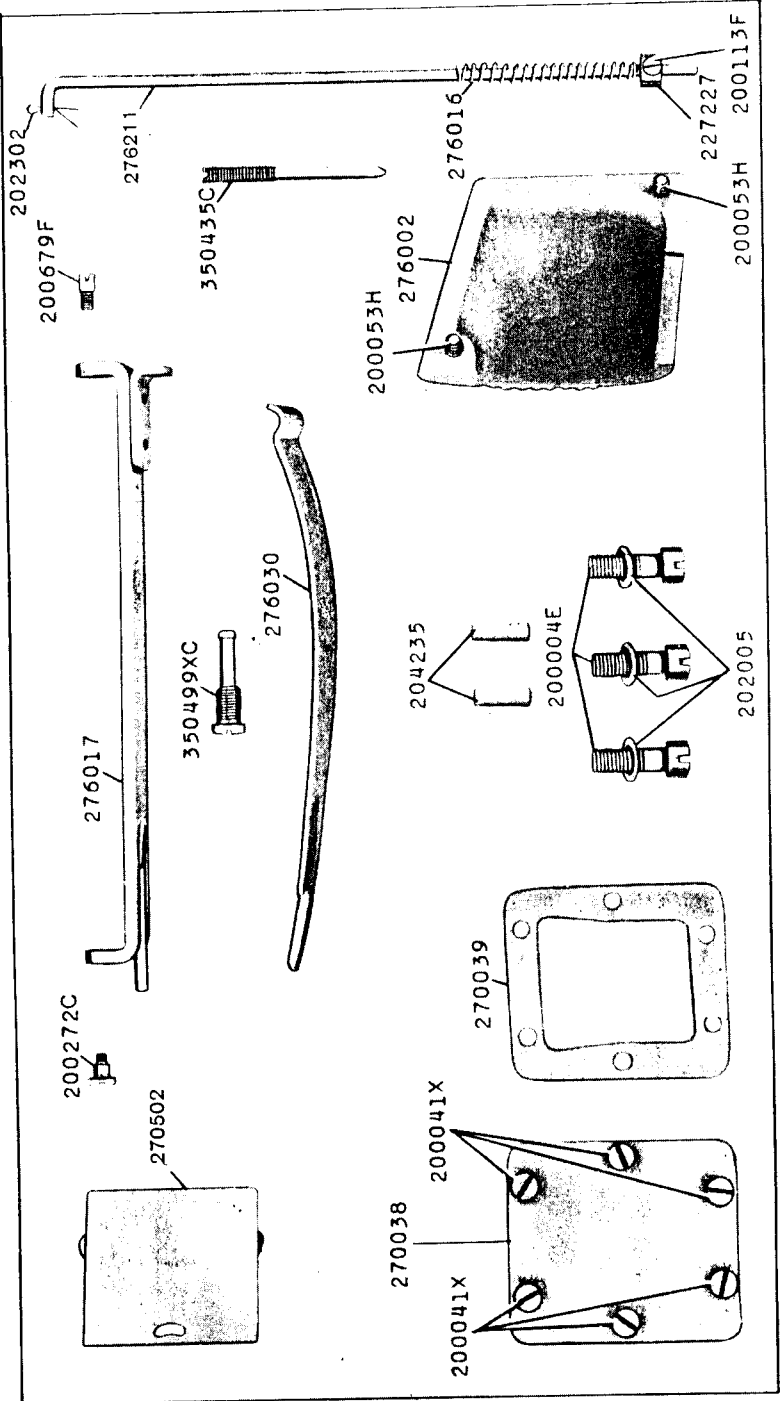
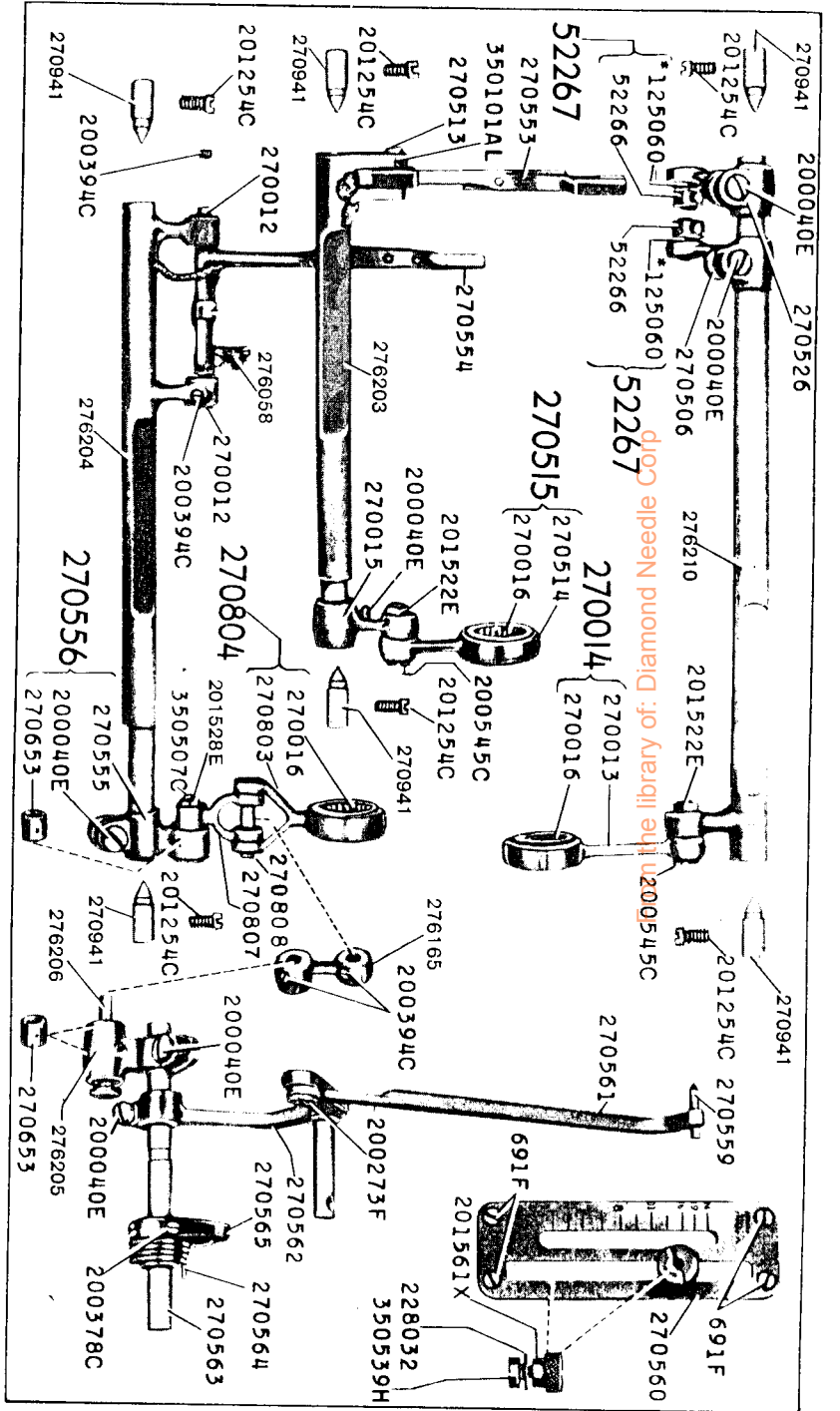

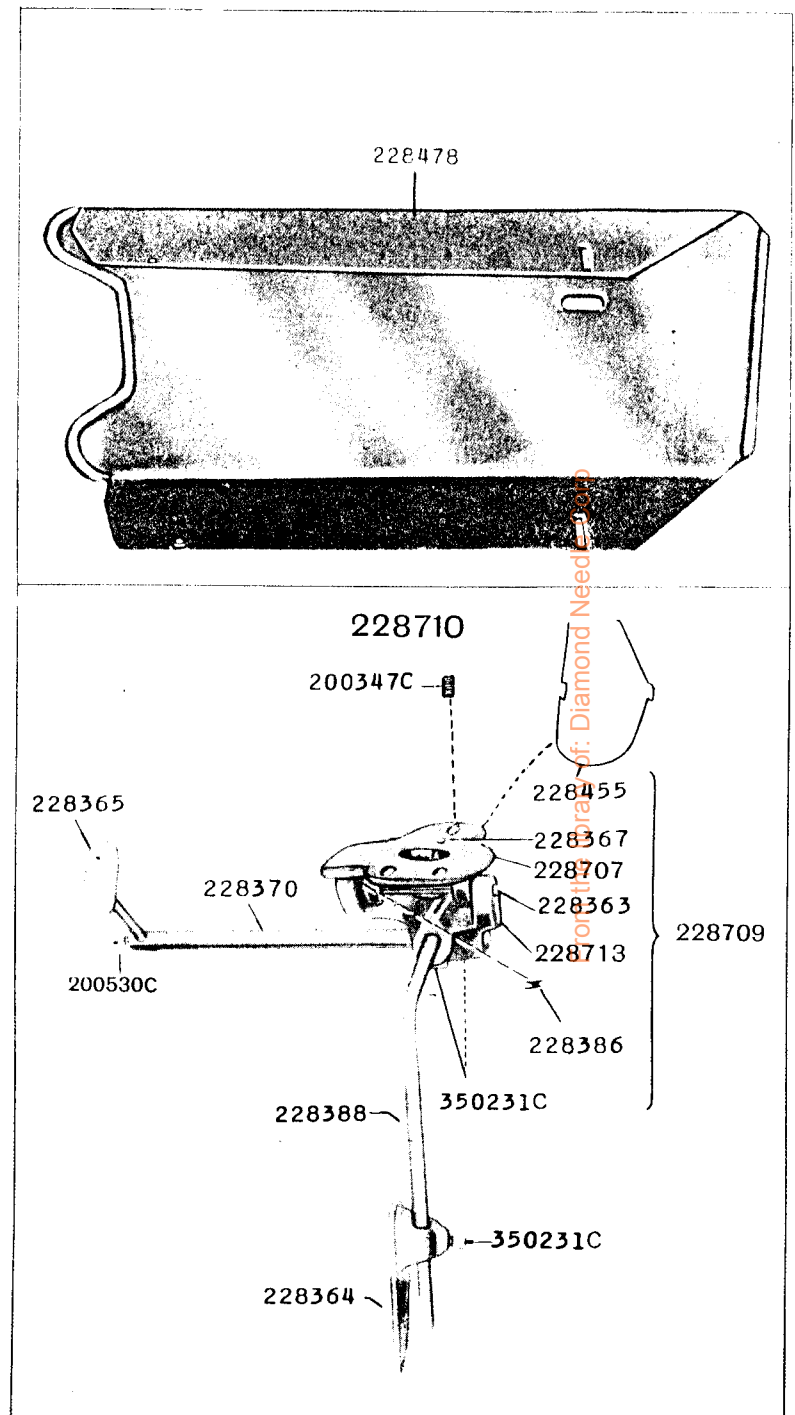
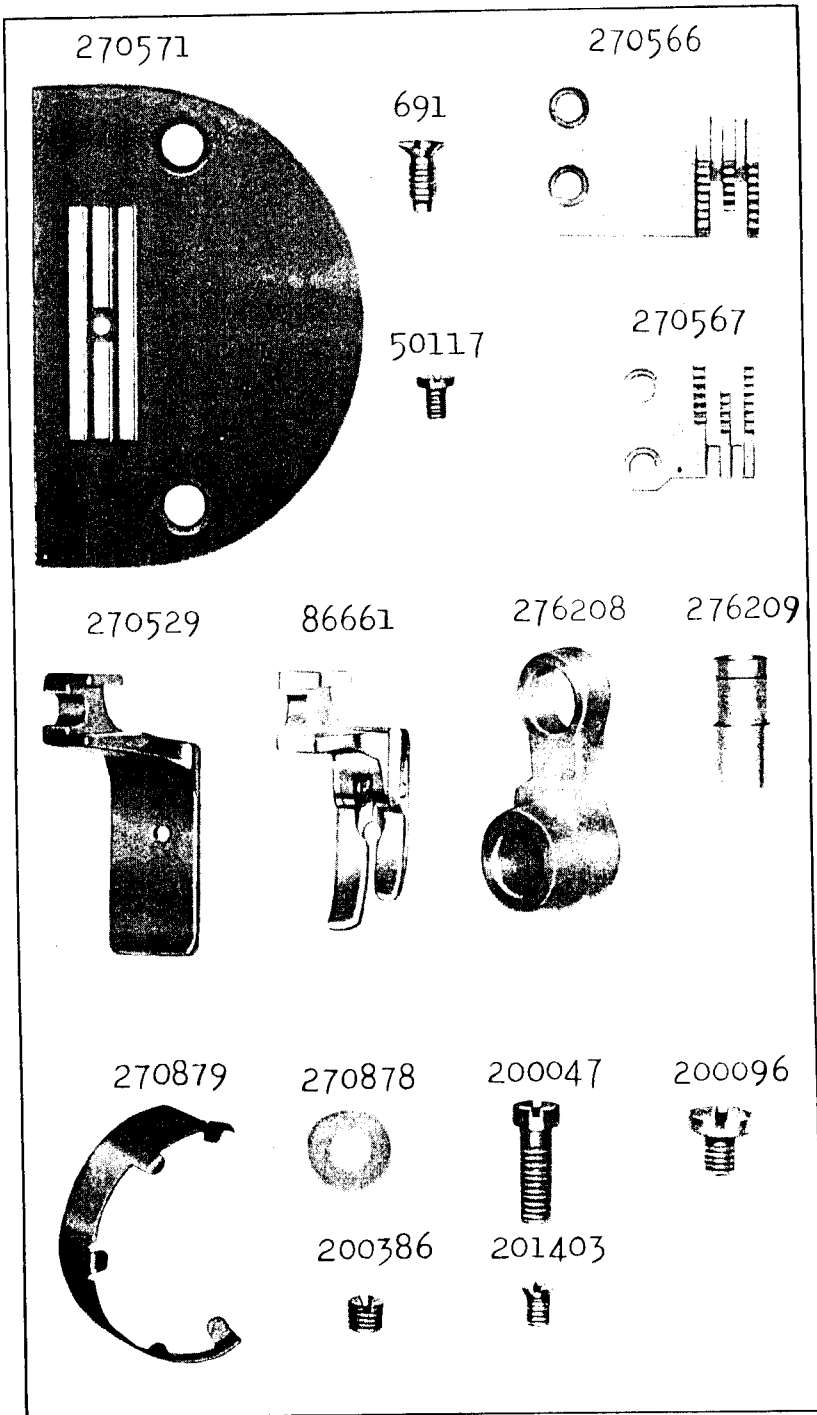

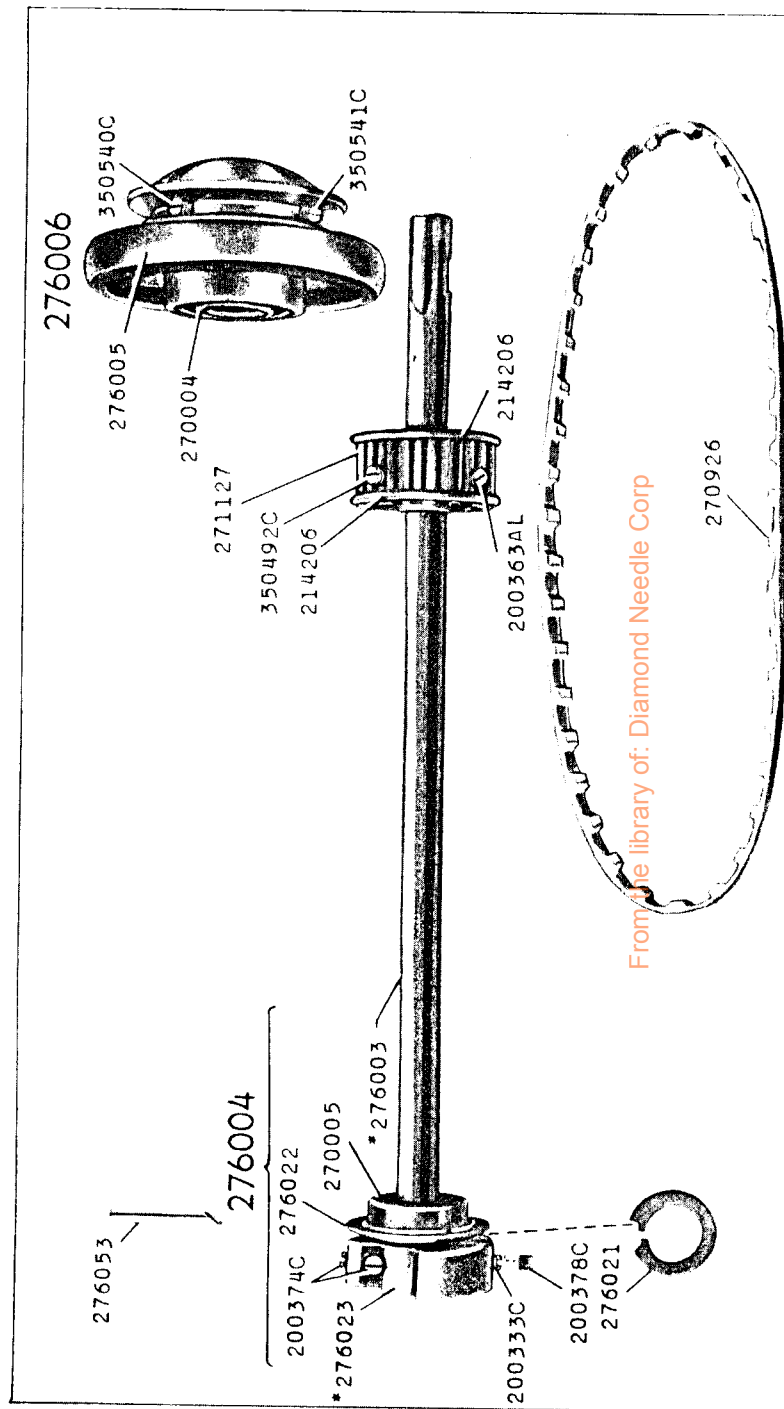
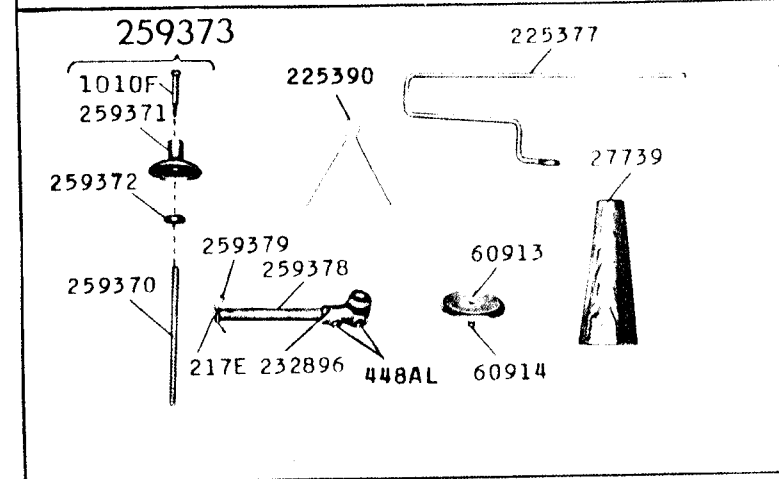
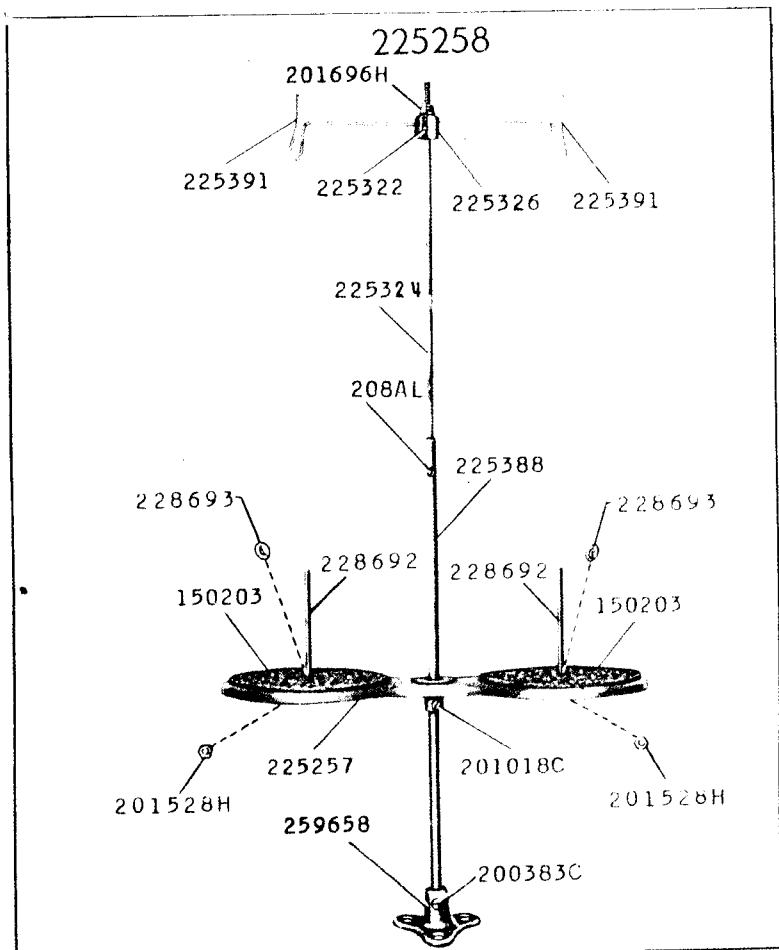

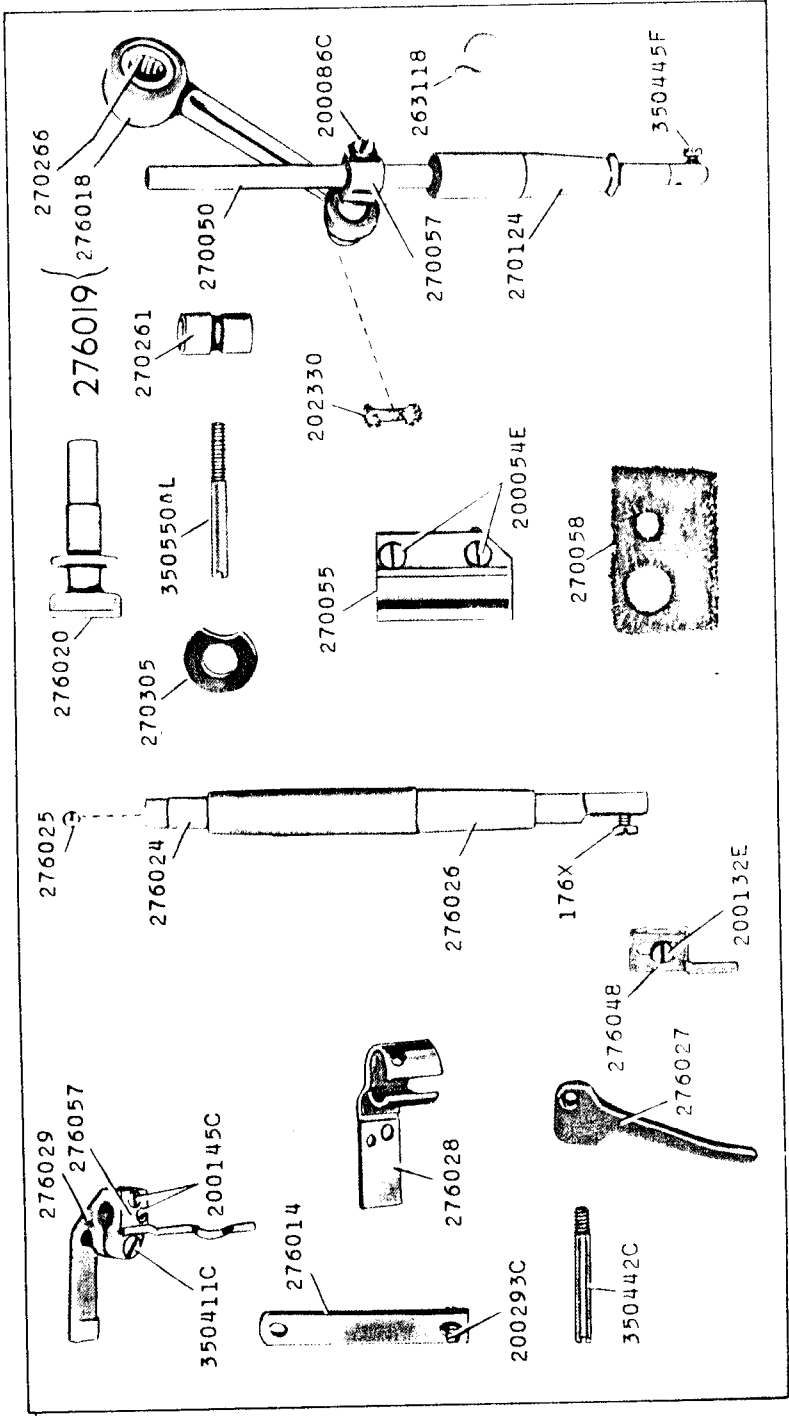

From the library of: Diamond Needle Corp